



## PET/CT Si78

- High Performance Preclinical Total Body PET and CT

# PET and CT Combined

## Two Best in Class Imaging Technologies, Combined in One Instrument

Bruker's Full Field of View Accuracy SiPM PET technology is now combined with low dose - high throughput SkyScan microCT. Offering a unique instrument, with supreme PET/CT imaging performance.

### Total Body PET for Mice & Rats

#### Fast Scan Times, Unparalleled Quality

The PET/CT Si78 features homogeneous, high-resolution, and quantitative PET/CT imaging with a large field of view of 80 x up to 200 mm.

The unique low dose X-ray technology, combined with ultra-fast full body 3D CT scanning, the familiar ParaVision 360 software and a high-precision motorized animal transport system, simplifies your workflow.

#### The World of Multi-Modality Preclinical Imaging

- Total Body PET for mice and rats
- Full Field-of-View PET quantitative accuracy
- Low-dose, fast CT scans for longitudinal studies
- ParaVision 360 preclinical imaging workflows using validated multi-modal in vivo protocols & scan programs
- Interactive scan planning
- Accurate touch screen animal positioning
- Double-sided and fully open access to the imaging gantry with a minimum distance to the PET FOV for kinetic tracer studies
- Single click, auto connect animal cradles for mice and rats, including anesthesia supply, animal warming, respiration and ECG sensors and gas exhaust sensors

#### Unlimited possibilities for *in vivo* preclinical imaging applications



**Finest detail in every organ**

CT doses mGy/MBq PET  
PET/CT SUV ID/mL ID/mL  
low dose mGy/MBq PET  
PET/CT CT doses SUV ID/mL  
μCi MBq low  
dose mGy/MBq PET/CT  
CT doses CT doses mGy/M-  
Bq PET PET/CT SUV SUV  
ID/mL μCi MBq CT doses

**Accurate Quantification**

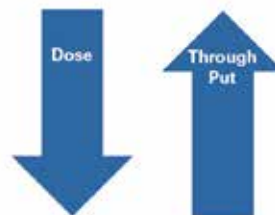

**Low Dose  
Fast Scan Times**



**Total Body FOV  
80 x 200 mm**

# Applications

## Functional, Structural and Metabolic Assessment

The PET/CT Si78 opens a broad spectrum of multi-modal PET/CT applications, from Oncology to Cardiac imaging.

### Oncology

#### Tumor Biology and Tracer Validation

Excellent CT soft tissue contrast of tumor margin facilitates accurate analysis of tracer uptake and kinetics. High resolution PET shows true tracer distribution and variation of PET tracer for studies of tumor microenvironment.

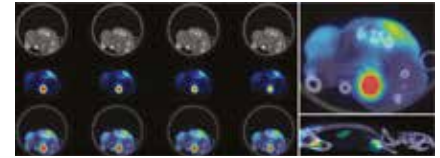

- Xenograft tumor mouse. 4 slice axial plane PET/CT
- <sup>18</sup>F-FDG tumor metabolic activity and bladder
- MicroCT (200 μm) with tumor margin visible

### Neurology

#### Neurodegenerative, Stroke, Addiction, Psychiatric

High resolution PET is required for accurate quantitative measurement of regional changes in brain activity. This is critical in studies where sub regions are differentially affected by diseases, psychoactive agents, and where validation of new tracers is being made.

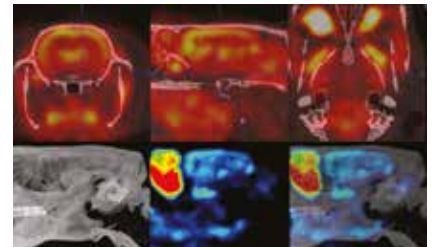

- In the example provided <sup>18</sup>F-FDG metabolic activity of cerebral cortex, Harderian glands, and jaw muscles clearly resolved.
- MicroCT well defined skull, sinuses, and jaw structures.

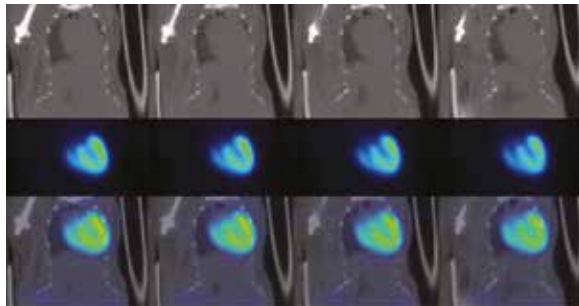

- Normal mouse - 4 slice coronal plane PET/CT
- <sup>18</sup>F-FDG heart right ventricle clearly resolved in ungated acquisition
- MicroCT (200 μm) with lung and heart shadow

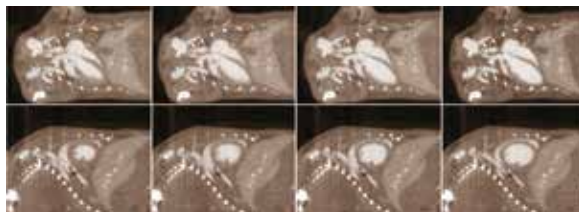

- Normal mouse with contrast enhanced microCT cardiac imaging with 4 gates
- Enables cardiac analysis – e.g. ejection fraction

### Cardiovascular

#### Metabolism, Inflammation, Perfusion, & Functional Imaging

High resolution cardiac imaging is crucial for resolving features of cardiac disease in small animals, including plaques and ischemia.

Contrast enhanced and gated microCT allow for clear visualization of the small animal vascular system.

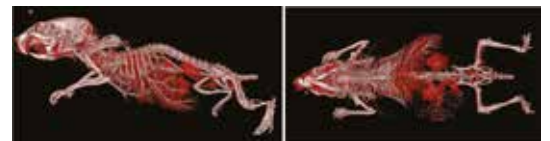

- LepOB (6 wk.) obese mouse
- Contrast enhanced microCT with clearly defined heart, vena cava, and liver vasculature

# Applications

## Total Body Imaging Tracer Dynamic Imaging and Kinetics

Total body PET allows for kinetic modeling potentially using anatomically distant input functions.

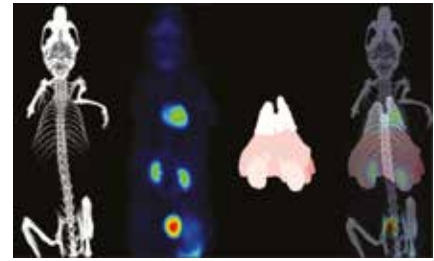

- Normal mouse PET/CT with organ atlas
- <sup>18</sup>F-FDG & microCT (200 μm)

## Lung Imaging Pulmonary - Oncology, Fibrosis, Emphysema

Standard (left) versus respiratory gated (right) microCT

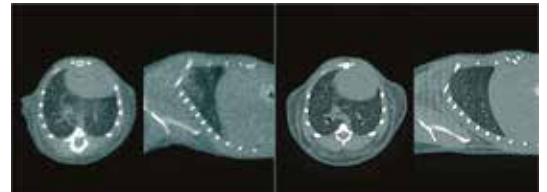

- Standard (left) versus respiratory gated (right) microCT

## Bone Imaging Skeletal - Bone Density, Orthopedics, Metabolism

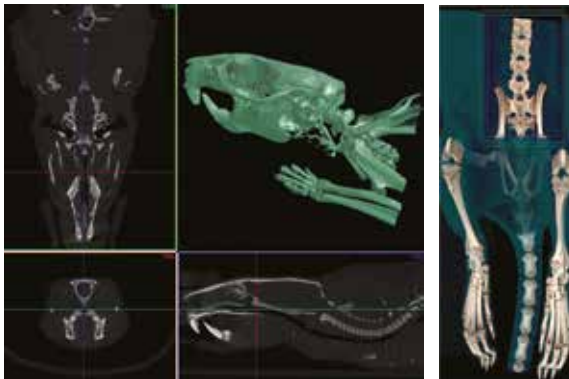

- Normal Sprague-Dawley Rat
- microCT – spine, skull, growth plates, and dental structure

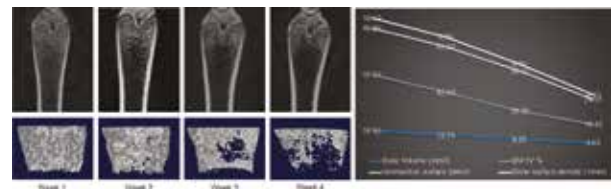

- Sprague-Dawley (6 mo.) OVX osteoporosis disease model
- Scanned weekly post surgery
- microCT distal femur trabecular bone analysis with longitudinal disease progression

## Obesity and Metabolics Fat/Lean Mass, Brown Adipose Tissue

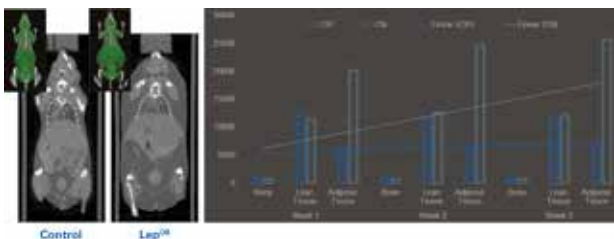

- LepOB (6 wk.) obese and control mice imaged weekly
- microCT and tissue segmentation and quantification with longitudinal disease progression

# Complete Solution

Designed With the Researcher in Mind



## Simplified Workflow

Easy to use, a 5-step workflow, designed with the researcher in mind.



## Software

### Fully integrated ParaVision 360

ParaVision 360 enters the world of seamless multimodal imaging. Modern imaging laboratories using PET, CT or MR instruments profit from the fully integrated common imaging platform. The simplicity and uniformity across the range of instrumentation allows operators to put their focus on their research.

The hybrid imaging workflows are identical for all modalities, enabling easier workflows and higher throughput.

All hybrid images, protocols and subjects are in one place. Inherent co-registration, image fusion, data processing and analysis.

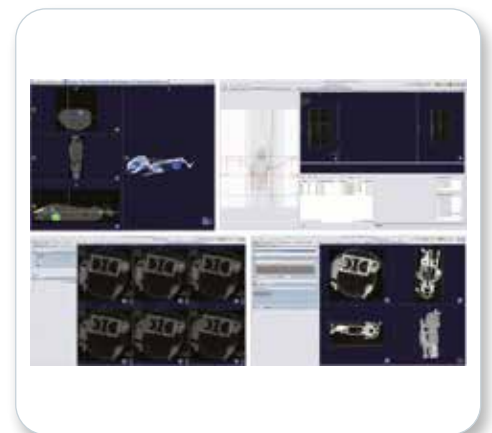



# Animal Handling

## Animal Cradles

Our animal beds are designed for easy setup and workflow in the preclinical imaging lab. Animal life support and PET tracer application equipment can be interfaced to the main instrument with a single clip on action.

Animal beds in different sizes are available for mice, rats and for multi-mouse imaging. The cradles provide ports with automatic connection to the scanner for

- Anesthesia systems
- Life monitoring systems
- PET catheter feedthroughs
- Trigger Signals for gated CT and PET, i.e. for cardiac or respiration gating



## Animal Cradle Preparation Station

Single click tabletop adapter preparation station for animal cradles is available to allow preparation of the animal and supervision of the next animal easy, prior to imaging or while an instrument is still in use.

## Animal Transport System

High-precision and computer-controlled animal transport system in combination with dedicated animal cradles enables in vivo imaging with fully automatic high precision co-registration and fusion of imaging data.

### The automatic transport system offers:

- Scout-view with interactive scan position planning
- Touchscreen operation with gloves
- Completely open animal access from two side and easy tracer injection
- Fully x-ray shielded when closed



# Key Features and Specifications

## Key Features

PET Imaging	MicroCT imaging
Total body PET FOV ~ 80 x 150 (200 mm)	Total body CT FOV ~ 80 x 80 (180 mm)
Full Field Accuracy across the entire FOV	Fastest total body CT scan in 7.2 seconds
Spatial Resolution up to 0.7 mm	Image Resolution up to 50 $\mu$ m
Excellent NEMA Count Rates for mice and rats	Low dose scanning < 6 mGy
ParaVision 360 multi-modal preclinical software with common imaging workflows and databases	
Multi-modal animal management and physiological monitoring	
Gated PET and CT imaging for cardiac imaging or respiration triggering	
Double sided and completely open access to animal transport system and scanner gantry	
Automated co-registration, image fusion, image analysis and preclinical DICOM or NIFTI image export	

## Performance Specifications

PET Imaging	CT Imaging
Transaxial FOV: 80 mm	Transaxial FOV: 80 mm
Axial FOV (single scan / max): 150 / 200 mm	Axial FOV (single scan / max): 80/180 mm
Spatial Resolution: up to 0.7 mm	CMOS flat panel: 1944x1536, 14 bit
Sensitivity: 12%	Nominal resolution: better 52 $\mu$ m
Energy Resolution: 17%	Radiation shielding: < 1 $\mu$ Sv/h at 10cm from surface
NEMA NECR Mouse: 560 kcps @ 21 MBq	
NEMA NECR Rat: 280 kcps @ 21 MBq	
NEMA Spatial Resolution: better than 1.2 mm	
NEMA Sensitivity (50% energy window): 9%	

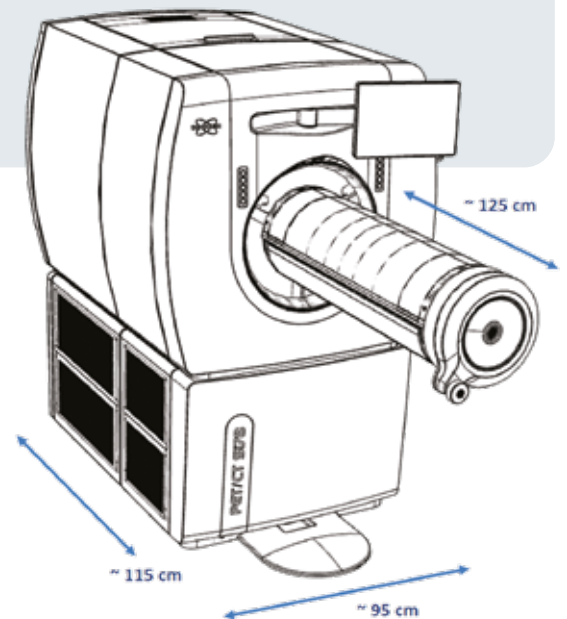



[info@bruker.com](mailto:info@bruker.com)  
[www.bruker.com](http://www.bruker.com)